

A  
SIZE

PROJECTIONS



TOLERANCES UNLESS OTHERWISE SPECIFIED:

PLACES		INCH	NOTE:
.XX	±	.030	ACCEPTABLE BURR ± 10% OF MATERIAL THICKNESS ALL TOLERANCES ARE NON-CUMULATIVE ALL DIMENSIONS APPLY TO PART BEFORE ANY FINISH IS APPLIED
.XXX	±	.015	
.XXXX	±	.005	
ANGLE	±	3°	

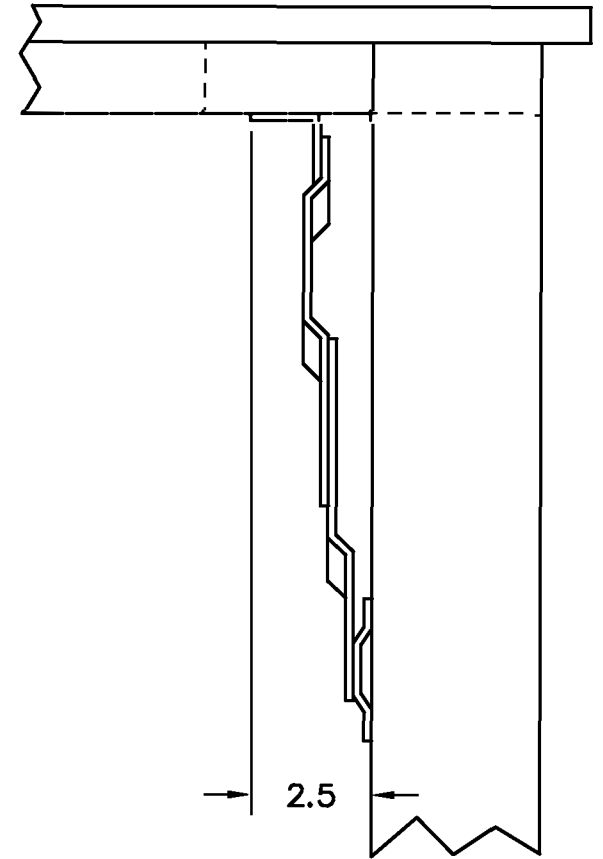
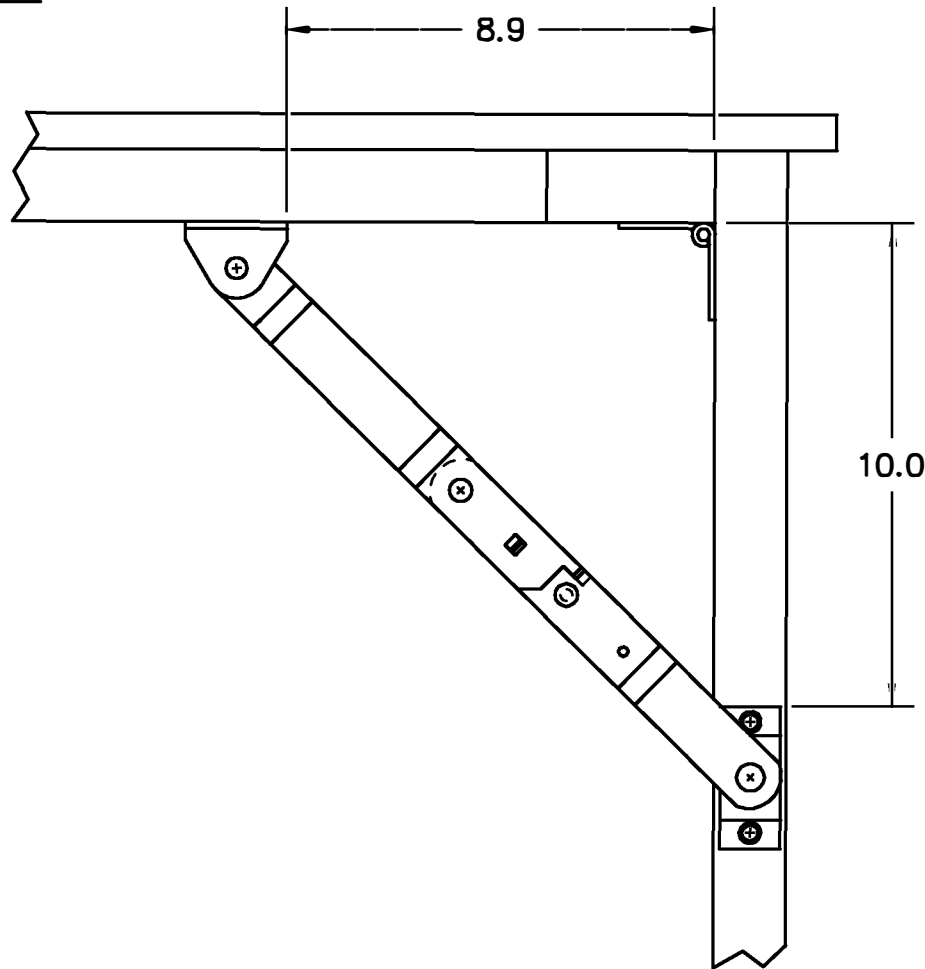

info@hardwaresource.com  
1 (858) 322-6353

Left Hand: SKU 204002  
Right Hand: SKU 204004